



Conforms to the requirements of **BS EN 61340-5-1**. Based on test method **IEC 61340-2-3**
Compliance verification limit values: $R_g < 1 \times 10^9 \Omega$ / $R_{gp} < 1 \times 10^9 \Omega$ / $R_{p-p} < 1 \times 10^9 \Omega$

Specifications and features

- Manufactured in the UK
- Strong conductive plastic construction
- Adjustable binder holder included (optional 2nd holder)
- Four lockable conductive castors as standard
- Conductive levelling feet version available
- Adjustable container runners
- Compatible with multiple WEZ containers variants
- Common point ground as standard
- User Manual and Declaration of Conformity provided
- Compliance Verification Certificate provided
- Conductive foam inserts supplied upon request
- Bespoke versions available (MOQs may apply)

ESD container trolley – features overview

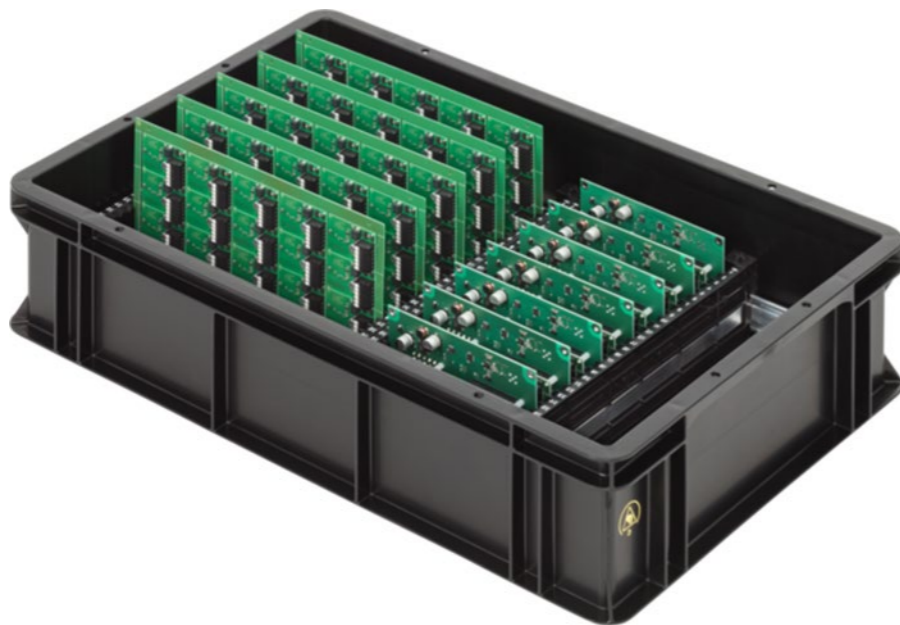

Designed for EPA



10mm ground point



ESD protective



Conductive castors



Issue 1

Standard container ordering combinations

Trolley height – overall dimensions (with castors): H: 1011 x W: 580 x D: 610 mm

6 container trolley

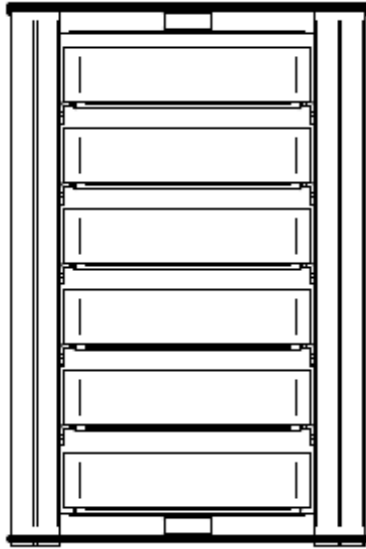

WEZ container variant 1

Dimensions

H: 101mm
W: 400mm
D: 600 mm

3 container trolley

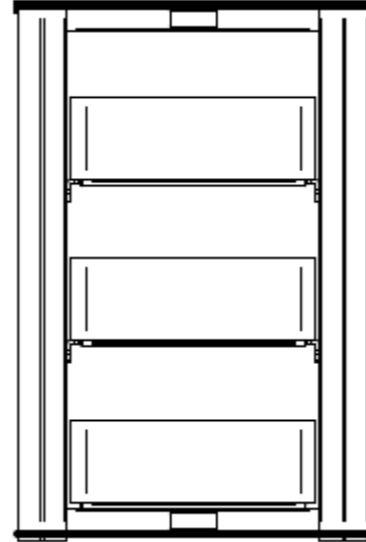

WEZ container variant 2

Dimensions

H: 145mm
W: 400mm
D: 600 mm

3 container trolley

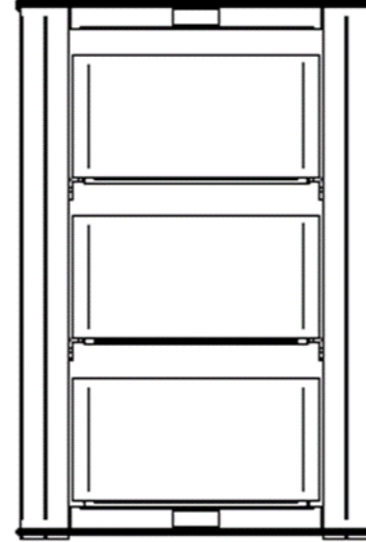

WEZ container variant 3

Dimensions

H: 212mm
W: 400mm
D: 600 mm

2 container trolley

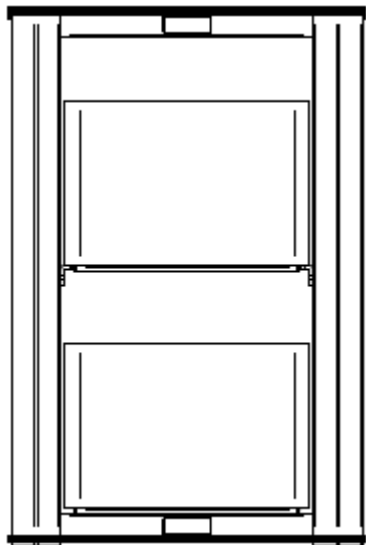

WEZ container variant 4

Dimensions

H: 278mm
W: 400mm
D: 600 mm

2 container trolley

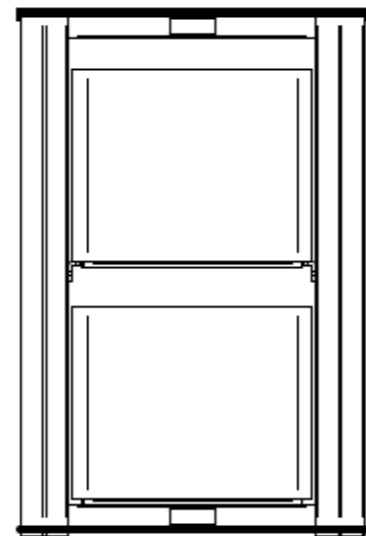

WEZ container variant 5

Dimensions

H: 320mm
W: 400mm
D: 600 mm

Container runner spacing dimensions

Note: the runners can either be removed or repositioned at the below spacing points.



HOW TO ORDER

Order example

ESDWCT/6/1/C

6 container trolley, container variant 1 with conductive castors



ESDWCT / **6** / **1** / **C**

Installed container runners

6	6 containers
3	3 containers
2	2 containers
0	None fitted

Note: spare runners and fixings will be supplied loose

Mounting options

C	Conductive castors
F	Conductive feet

Container variant

0	None supplied
1	Variant 1
2	Variant 2
3	Variant 3
4	Variant 4
5	Variant 5

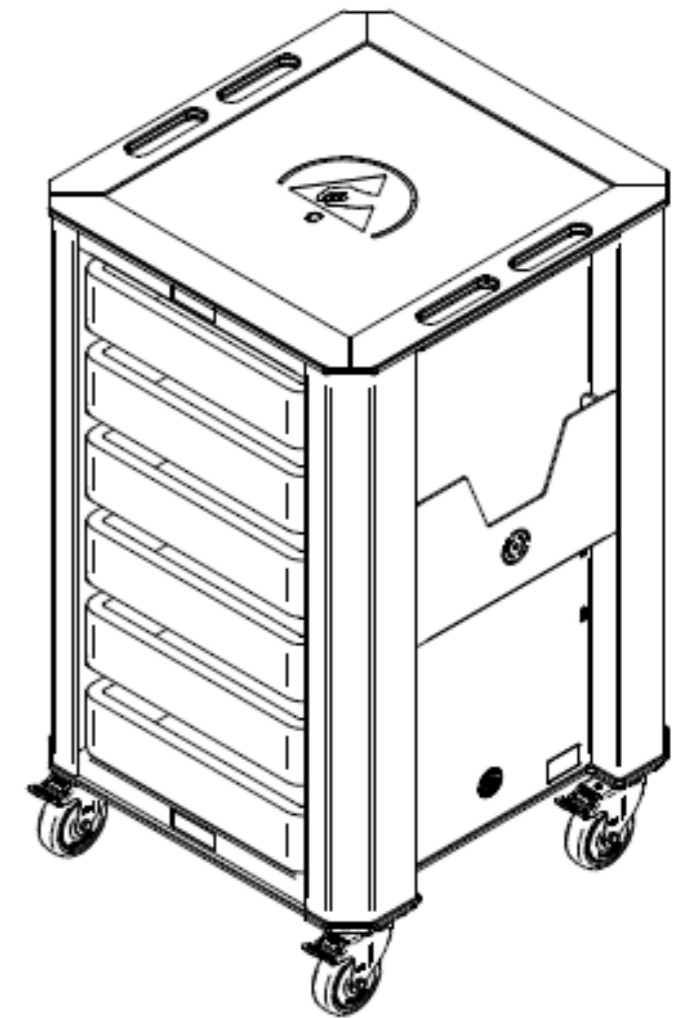
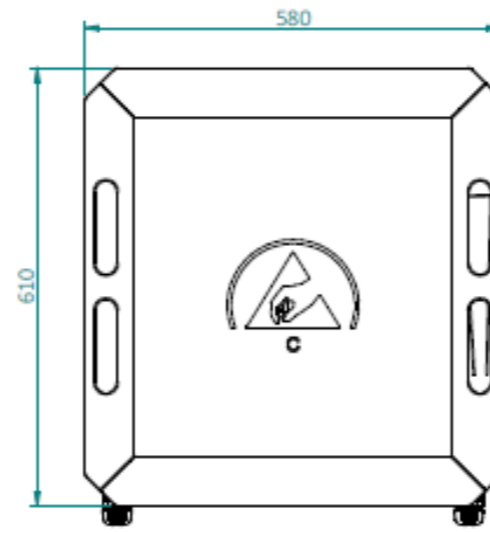
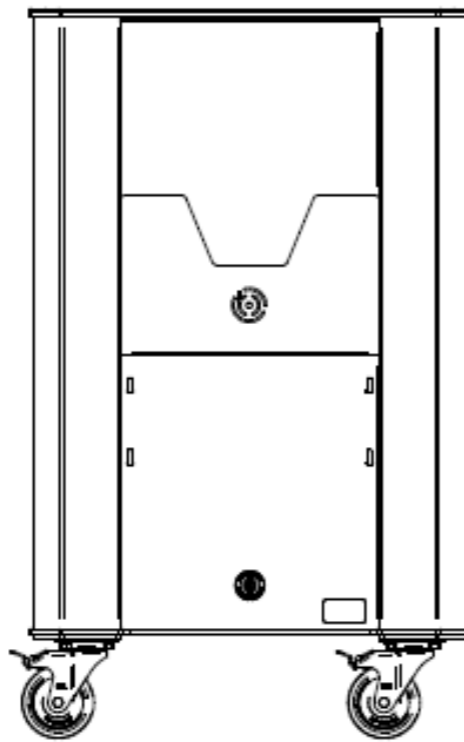
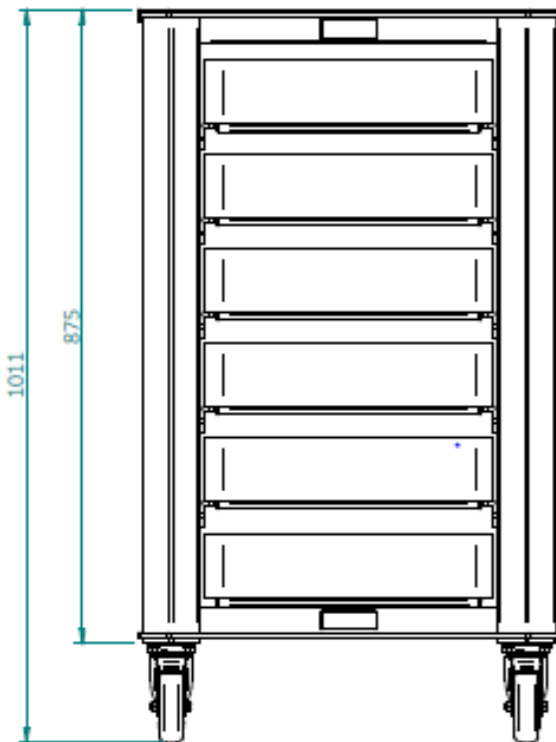

Issue 1

Nuwco is a division of CamdenBoss Ltd. 60 James Carter Road, Mildenhall, IP28 7DE

www.nuwco.com | sales@nuwco.com | 01842 751500